

HEAT *Quest 1500*

INFRARED ZONE HEATING SYSTEM

OWNER'S MANUAL

Model No. **ATI-HQ**

www.advancedtechinfrared.com

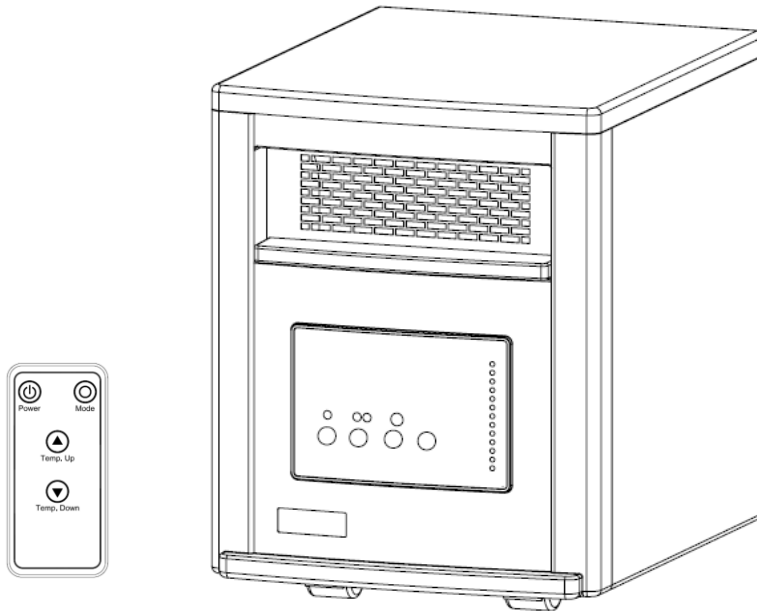

ETL
LISTED
c **ETL** us
Intertek
3182690

PLEASE SAVE THESE INSTRUCTIONS

WARNING: READ THIS OWNER'S MANUAL CAREFULLY BEFORE USE.

Thank you for choosing a RD-WORKS Infrared Zone Heating System. This owner's manual will provide you with valuable information necessary for the proper care and maintenance of your new product. Please take a few moments to thoroughly read the instructions and familiarize yourself with all the operational aspects of your new heater.

IMPORTANT INSTRUCTIONS

When using this electric unit, basic safety precautions should always be followed to reduce the risk of fire, electric shock, and injury to persons, including the following:

1. Read ALL instructions before using this unit.
2. CAUTION: Risk of Electric Shock. DO NOT open or try to repair the heater yourself.
3. This heater may get hot when in use. To avoid burns, DO NOT let bare skin touch hot surfaces. If provided, use handles when moving this heater.
4. Keep combustible materials, such as furniture, pillows, bedding, paper, clothes, and curtains at least 3 ft from the front of the heater and keep them away from the sides, top, and rear. DO NOT place towels or other objects on the heater.
5. Extreme caution is necessary when any heater is used by or near children or the disabled, or when the heater is left operating and unattended.
6. DO NOT operate any heater with a damaged cord or after the heater malfunctions, has been dropped or damaged in any manner. Return heater to authorized service facility for examination, electrical or mechanical adjustment, or repair.
7. This heater is not intended for use in bathrooms, laundry areas and similar indoor locations. NEVER locate heater where it may fall into a bathtub or other water container. To protect against electrical hazards, DO NOT immerse in water or other liquids.
8. DO NOT touch the control panel or plug with a wet hand.
9. DO NOT run cord under carpeting. DO NOT cover cord with throw rugs, runners, or similar coverings. Arrange cord away from traffic area and where it will not be tripped over.
10. DO NOT insert or allow foreign objects to enter any ventilation or exhaust opening as this may cause an electric shock or fire, or damage the heater.
11. To prevent a possible fire, DO NOT block the air intakes or exhaust in any manner. DO NOT use on soft surfaces, like a bed, where openings may become blocked.
12. A heater has hot and arcing or sparking parts inside. DO NOT use in areas where gasoline, paint, explosive and/or flammable liquids are used or stored. Keep unit away from heated surfaces and open flames.
13. Always plug heaters directly into a wall outlet/receptacle. Never use with an extension cord or relocatable power tap (outlet/power strip).
14. To avoid fire or shock hazard, plug the unit directly into a 120 V AC electrical outlet.

15. To disconnect heater, turn controls to OFF, then remove plug from outlet. Pull firmly on the plug, DO NOT unplug by pulling on the cord.
16. Always unplug the unit before moving or cleaning, or whenever the heater is not in use.
17. Use only for intended household use as described in this manual. Any other use not recommended by the manufacturer may cause fire, electric shock, or injury to persons. The use of attachments not recommended or sold by unauthorized dealers may cause hazards.
18. Always use on a dry, level surface. Use on floor only.
19. DO NOT use outdoors.
20. WARNING: To reduce the risk of fire or electric shock, DO NOT use this unit with any solid-state speed control device.
21. DO NOT attempt to repair or adjust any electrical or mechanical functions on this unit. Doing so will void your warranty. The inside of the unit contains no user serviceable parts. Qualified personnel should perform all servicing only.
22. Connect to properly grounded outlets only.
23. .Save these instructions.

SPECIFICATIONS

Voltage Rating	120 V (60Hz)
Power Consumption	1500W
Unit Size	13.1 in. (W) x 16.5 in. (D) x 16.7 in. (H)
Unit Weight	21.8 lbs

SAFETY FEATURES

Tip-Over Safety Feature

This heater is equipped with a tip-over safety feature. Once the heater is tipped over, an internal switch will automatically shut the heater off. Once the heater is restored an upright position, the heater will reset. To continue operation, turn on the heater using the supplied remote control or the control panel on the heater.

Overheat Safety Feature

This heater is equipped with a overheat safety feature. When the heaters internal components reach a certain temperature that could cause overheat and possible fire, the heater will automatically shut off.

WARNING: This heater has a voltage rating of 120 volts. The cord has a plug as shown in A. An adapter as shown in C is available for connecting three-blade grounding-type plugs to two-slot receptacles. The grounding lug extending from the adapter must be connected to a permanent ground such as a properly grounded outlet box. The adapter should not be used if a three-slot grounded receptacle is available.

DO NOT DEFEAT THE SAFETY PURPOSE OF THE GROUNDED PLUG.

WARNING: It is normal for the power cord to feel warm to the touch; however, a loose fit between the outlet and the plug may cause overheating of the plug. If this occurs, try inserting the plug into a different outlet. Contact a qualified electrician to inspect the original outlet for damage.

IN THE BOX

- INFRARED ZONE HEATING SYSTEM
- REMOTE CONTROL
- REMOTE CONTROL BATTERY
- INSTRUCTION BOOKLET

PRODUCT DIAGRAM

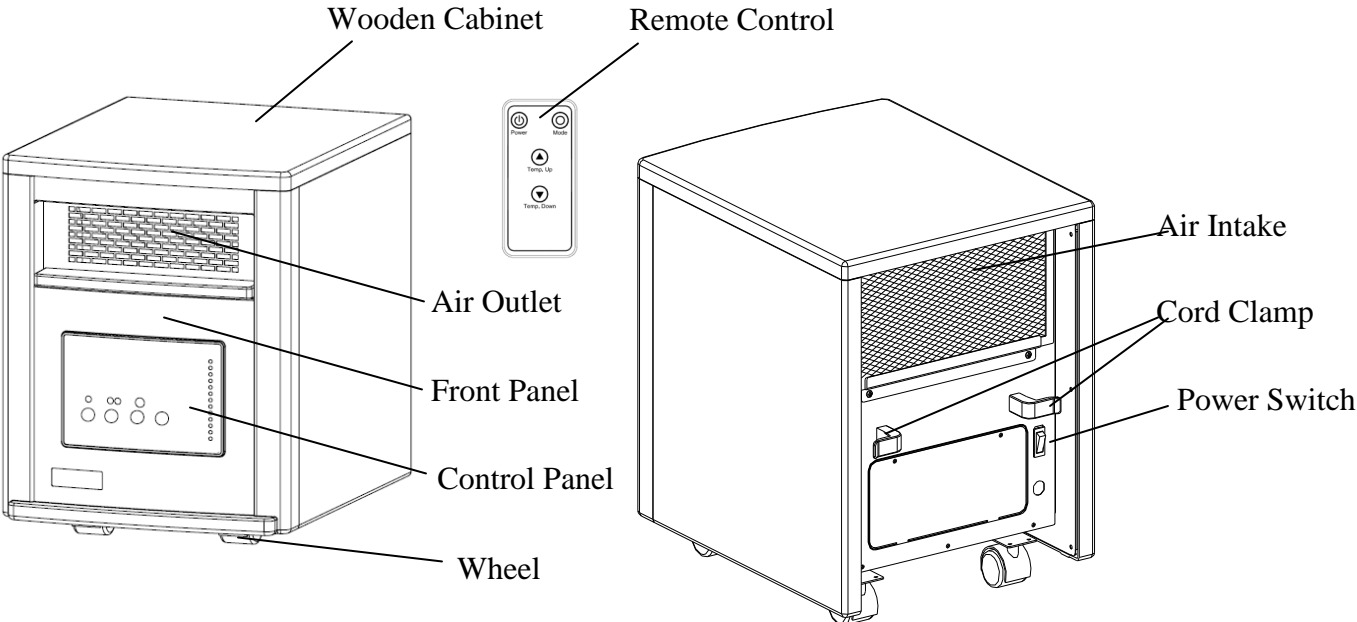

Control Panel

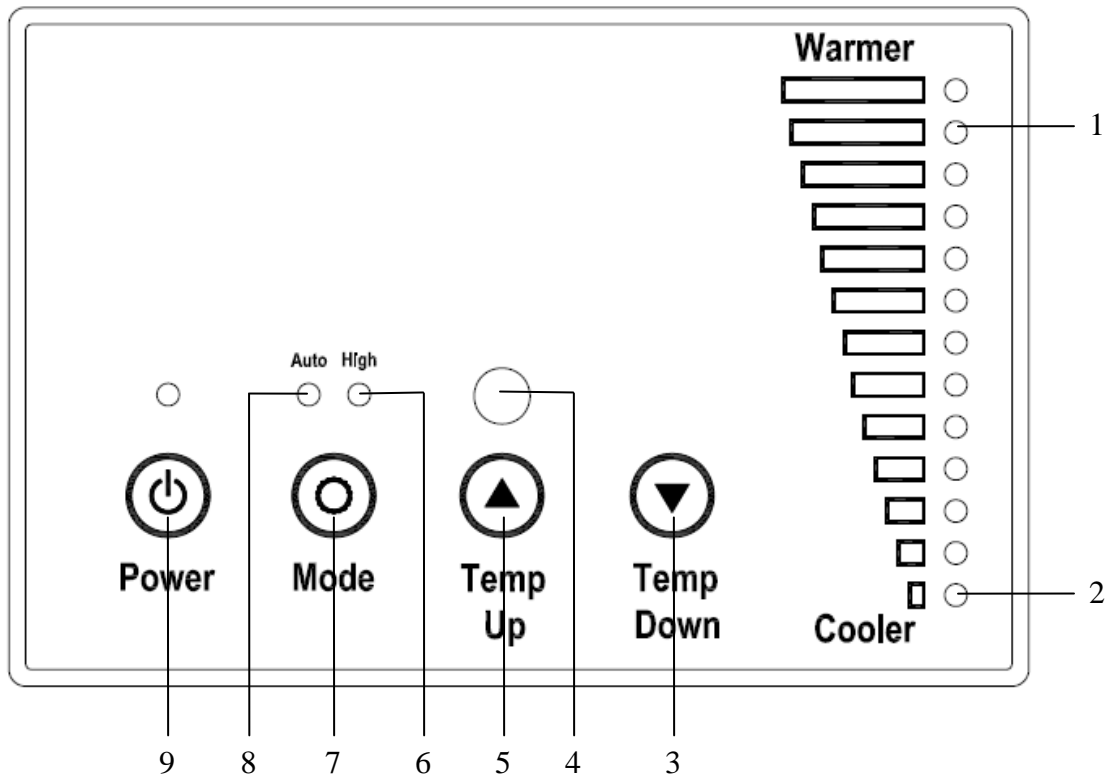

1. Indicating light of highest temp: Light's on when set at the maximum temp.
2. Indicating light of lowest temp: Light's on when set at the minimum temp.
3. Temp down button: For setting temp downward.
4. Signal-receiving window: For receiving remote control signal.
5. Temp up button: For setting temp upward.
6. Indicating light of high heat-up mode: Light's on when you select all-power heat-up mode.
7. Mode button: Used for selecting heat-up mode.
8. Indicating light of auto heat-up mode: Light's on when you select auto heat-up mode.
9. Power switch button: For power-on or off.

Remote Control

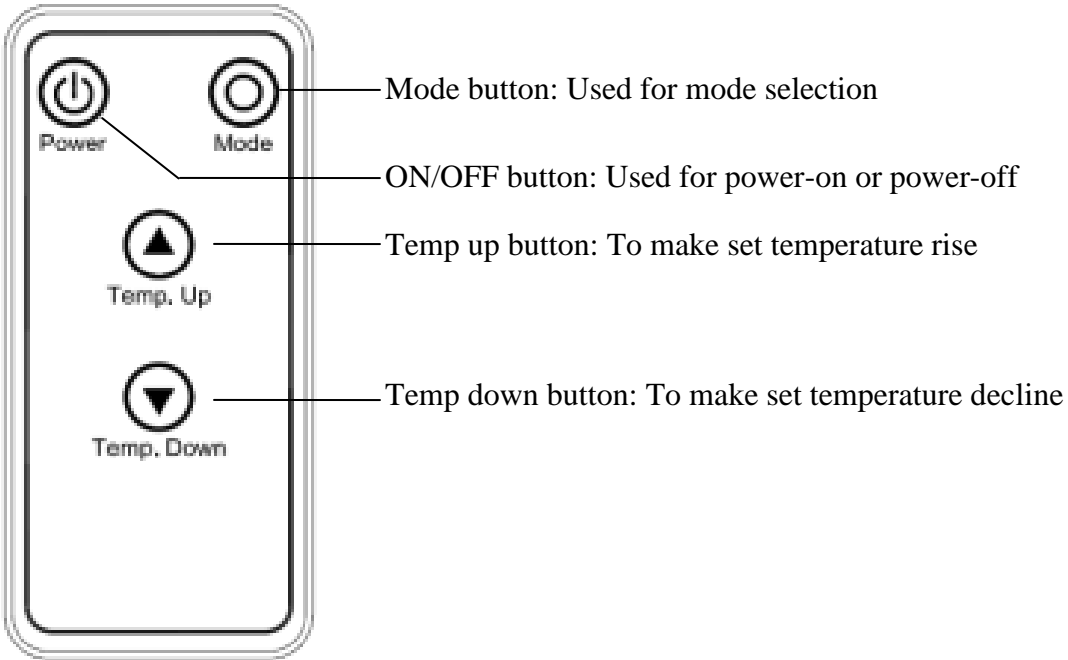

PREPARATION



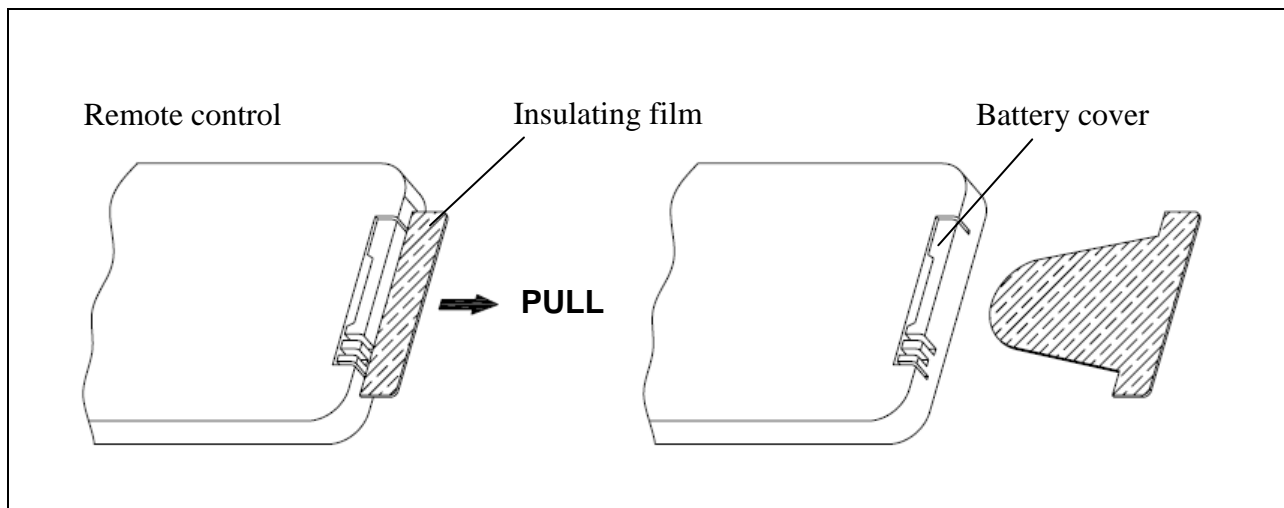

Place the heater on a firm, level surface and plug into a grounded 120V 60Hz power outlet and turn on the power switch in the rear of the unit. Only operate heater in upright position with caster wheels attached.

When using remote control, please pull out the insulating film as the following steps.





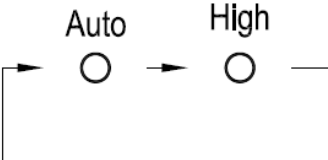

OPERATING INSTRUCTIONS

1、 Start and select working mode

 Power Or  Power	<p>Turn the heater on by pressing the Power button on the control panel or by pressing the Power button on the supplied remote control.</p> <p>Once power is off heating element will stop working at first. Fan will prolong working for 1 min to emit plenty of heat inside. This mark will indicate running during the 1 min.</p>
 Mode Or  Mode	<p>Select a heat setting.</p> <p>Press the Mode button to alternate between the two heat settings.</p>
	<p>Under Auto heat-up mode, when the value difference between set temp and room temp exceeds 5°F or so, the unit will run at full 1500w, otherwise run at 1000W; Under High heat-up mode, the unit runs at a stable 1500W, when room temp exceeds 86°F, heat-up stops.</p>



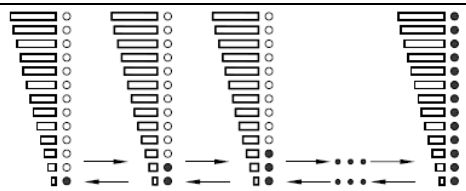

2、 Setting room temperature

Caution! Only in Auto heat-up mode can setting temperature be performed.

 Temp Down Or  Temp Up  Temp. Down Or  Temp. Up	<p>Adjust the thermostat by pressing the arrows on the control panel or remote control.</p>
	<p>Set temperature indication varies from 59°F to 86°F. Once you have chosen the desired temperature, the heater will remain on until the room temperature increases to the temperature on the digital display. The heater will cycle on and off to maintain the desired room temperature.</p>

5、 Setting electro lock

Function of electro lock can avoid misoperation from children. Locking can be set in both power-on and power-off modes.

 <p>Temp Down</p>	And	 <p>Temp Up</p>	<p>Press Temp Up and Temp Down buttons once for 3 seconds. Locking is fulfilled when a buzzer rings. When locked, control panel and remote control failed to function.</p>
 <p>Temp Down</p>	And	 <p>Temp Up</p>	<p>When release is needed, please re-press Temp Up and Temp Down buttons once for 3 seconds. Release is fulfilled when a buzzer rings. Lock indication disappears. Control panel and remote control return to function.</p>

MAINTENANCE

1. Turn off the power switch in the rear of the unit.
2. Unplug the unit and let it cool completely.
3. To keep the heater clean, the outer shell may be cleaned with a soft, damp cloth. You may use a mild detergent if necessary. After cleaning, dry the unit with a soft cloth.
CAUTION: DO NOT let liquid enter the heater.
4. **DO NOT** use alcohol, gasoline, abrasive powders, furniture polish, or rough brushes to clean the heater. This may cause damage or deterioration to the surface of the heater.
5. **DO NOT** immerse the heater in water.
6. Wait until the unit is completely dry before use.
7. Air filter needs cleaning after used 3 months. Please take down the filter as following steps. Flush and clean the taken –down filter with water, then dry it out and re-assemble.

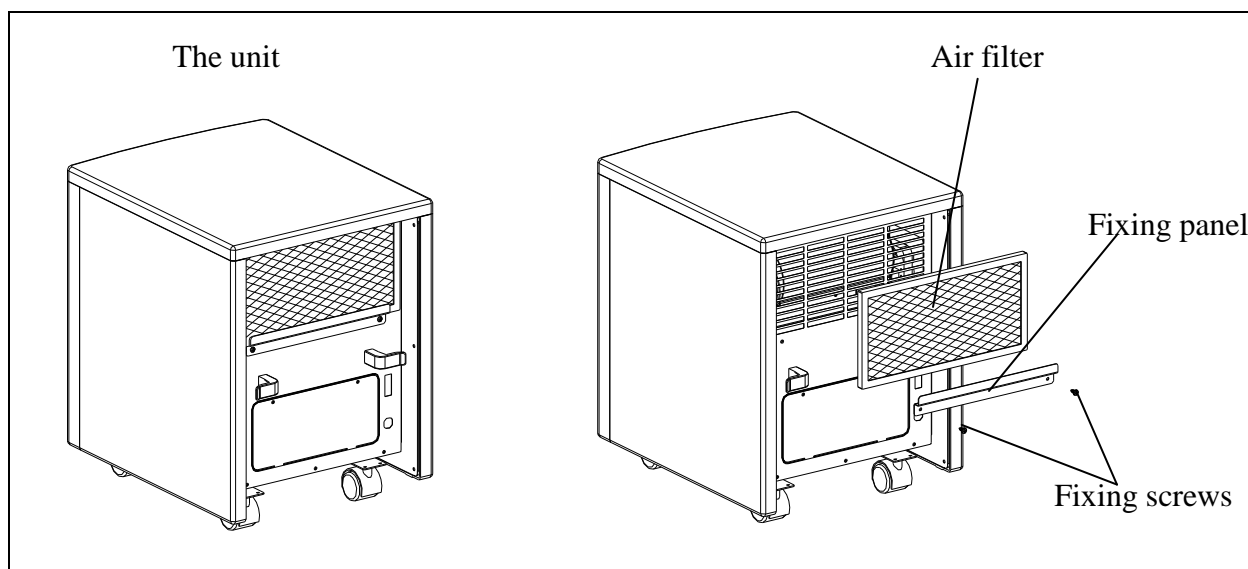

8. If won't use the unit for a long time, please take out battery in remote control according to following steps, then take care of the remote control.

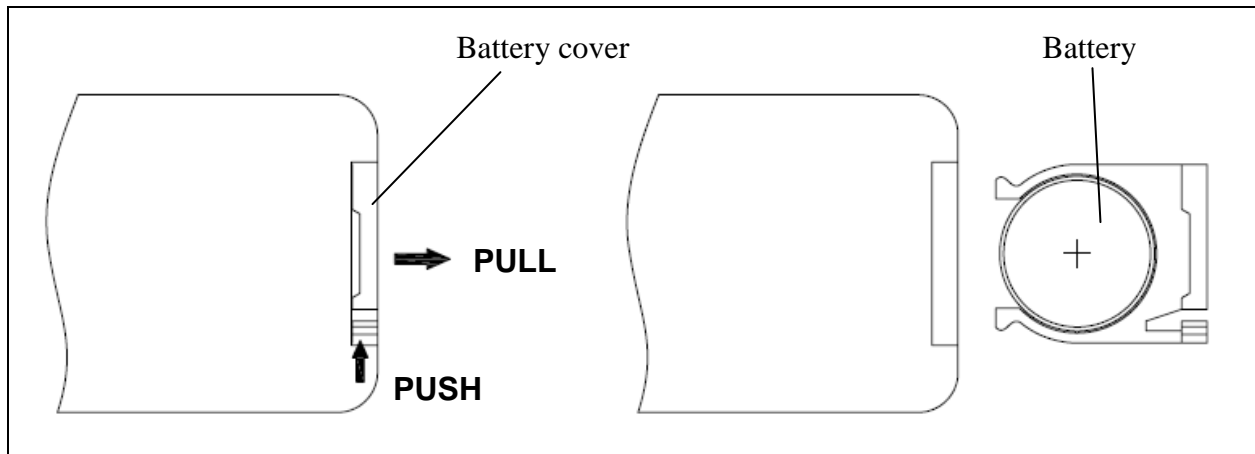

STORAGE

Store the heater in a cool, dry location when not in use. To prevent dust and dirt build-up, use the original packaging to repack the unit.

TROUBLESHOOTING

If the heater will not operate, please check the following before seeking repair of service:

1. Check if the power cord is plugged into an electrical outlet, if not, plug in.
2. Check if electricity to the main fuse is working.
3. Check if the battery in remote control is in good use, and if the insulating film is pulled out.

NOTE: The heater may not be operating if the thermostat is set **lower** than the room temperature. To begin operation, increase the thermostat temperature for a higher heat setting.